



### GENERAL FEATURES

- **Long Service Life** - Thick plate design and efficient gas recombination yield a service life expectancy of up to 10 years in standby mode.
- **Low Internal Resistance** - Superb high-rate discharge characteristics ensure reliable performance in UPS and Telecom applications.
- **Maintenance-Free, Non-Spillable** - Proven VRLA technology guarantees safe operation without maintenance and 'non-restricted article' status for transportation.
- **Low Self-Discharge** - Lead-calcium alloy grids and use of high purity lead account for superior shelf-life characteristics permitting storage for extended periods of time.
- **Designed-In Reliability** - Cutting-edge manufacturing and process control combined with meticulous quality assurance procedures guarantee consistent and dependable performance

### PERFORMANCE SPECIFICATIONS

<b>Nominal Voltage</b>	12V(6 cells)	
<b>Design Floating Life @25°C</b>	12 Years	
<b>Nominal Capacity @25°C</b>	20 hour rate	20.00Ah
	10 hour rate	19.20Ah
	5 hour rate	17.90Ah
	3 hour rate	16.20Ah
	1 hour rate	12.76Ah
<b>Internal Resistance</b>	Full Charged Battery@25°C <14mΩ	
<b>Energy Density (20-hr. rate)</b>	103.12W-h/l	
<b>Specific Energy (20-hr. rate)</b>	40.68W-h/kg	
<b>Shelf Life (nominal capacity at 20°C)</b>	1 Month	97%
	3 Months	91%
	6 Months	83%
<b>Max.Discharge Current@25°C</b>	7 Min.	60.0A
<b>Max Short-Duration Discharge Current</b>	10 Sec	200.0A
<b>Standby Use Charge (Constant Voltage) @25°C</b>	Initial Charging Current	
	Less than 6.0A	
<b>Cycle Use Charge (Constant Voltage) @25°C</b>	Initial Charging Current	
	Less than 6.0A	
<b>Operating Temperature Range</b>	Charge	-0°C to 50°C
	Discharge	-20°C to 60°C

### GENERAL FEATURES

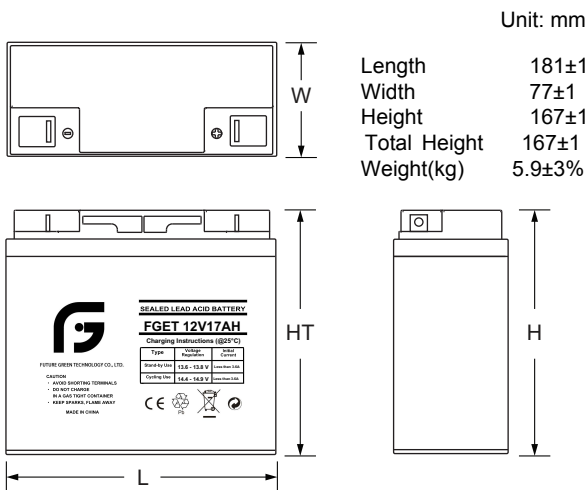

### TERMINALS

mm

- F2: Quick disconnect AMP, INC. Faston tabs, 0.250" x 0.032"
- NB2: Tin plated brass post with nut & bolt connectors

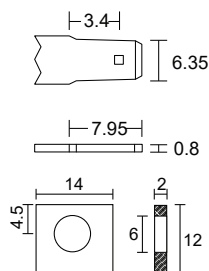

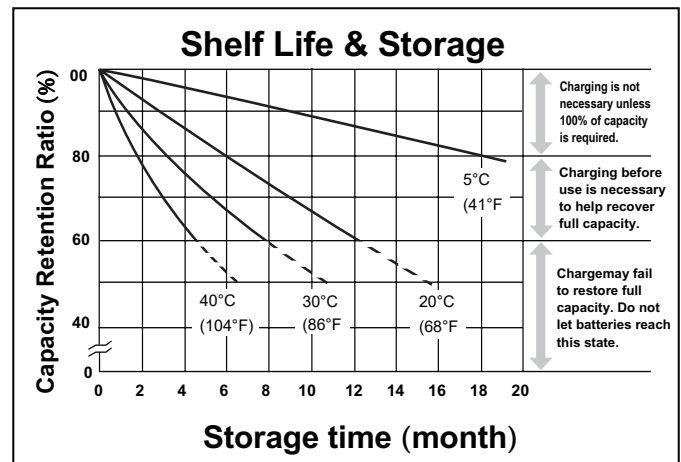
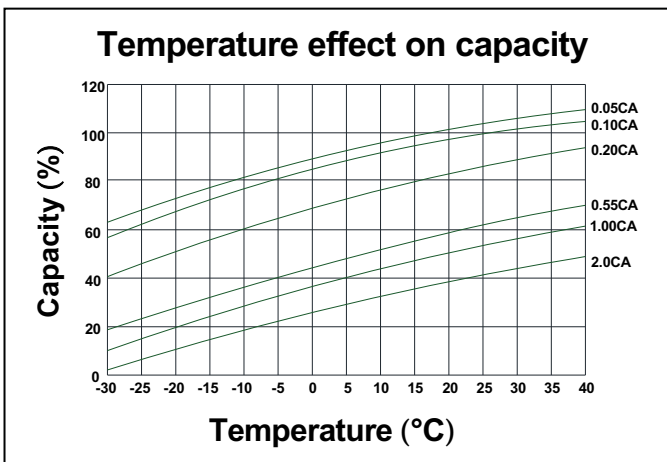
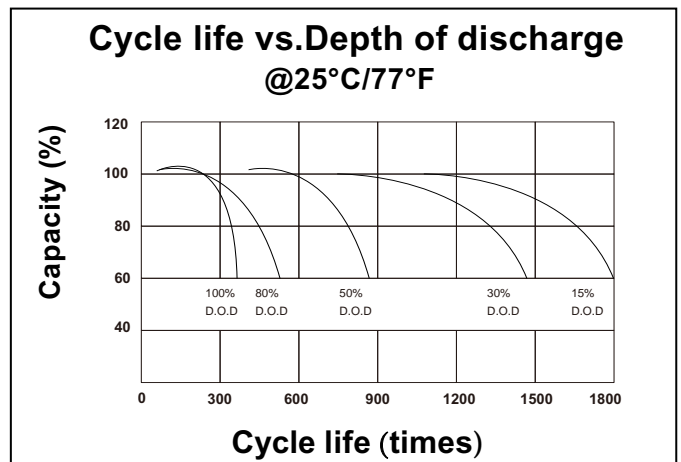
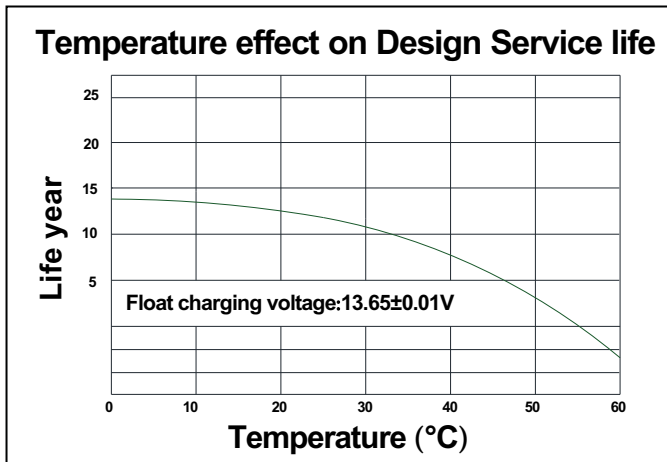
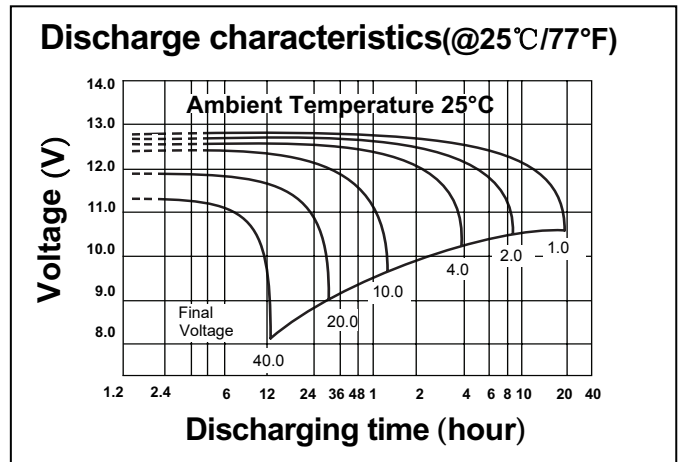
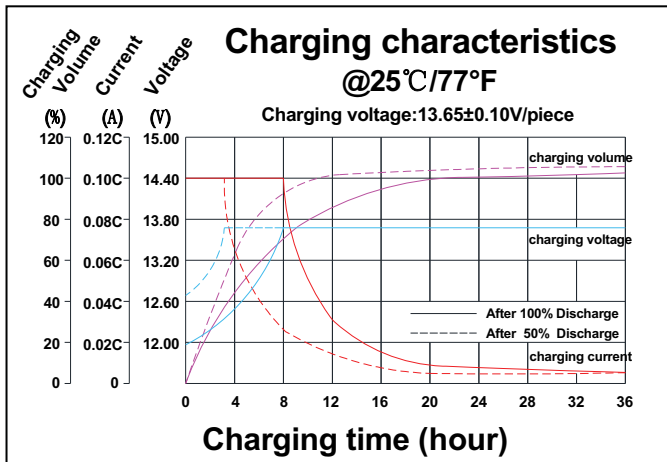

**CONSTANT CURRENT DISCHARGE RATINGS (Amperes at 25°C)**

F.V/Time	5MIN	10MIN	15MIN	30MIN	1HR	2HR	3HR	4HR	5HR	8HR	10HR	20HR
9.60V	79.30	51.72	38.15	22.08	12.76	7.527	5.472	4.357	3.678	2.458	2.002	1.041
10.0V	76.43	50.17	37.15	21.59	12.52	7.417	5.399	4.303	3.636	2.433	1.983	1.033
10.2V	72.70	48.15	35.84	20.95	12.21	7.270	5.302	4.231	3.579	2.400	1.957	1.022
10.5V	67.92	45.54	34.13	20.11	11.80	7.076	5.174	4.135	3.504	2.356	1.924	1.007
10.8V	61.88	42.19	31.93	19.03	11.26	6.822	5.004	4.009	3.405	2.298	1.879	0.987
11.1V	54.45	38.01	29.15	17.64	10.57	6.490	4.783	3.844	3.274	2.221	1.820	0.961